

For MrSteam Models MS90E, MS150E, MS225E, MS400E, MSSUPER1E, MSSUPER2E, MSSUPER3E, MX4E, MX5E, MX6E, CT6E, CT9E, CT12E, CT15E, SAH3000, SAH4500, and SAH6000

IMPORTANT NOTE: As you follow these instructions, you will notice warning and caution symbols. This blocked information is important for the safe and efficient installation and operation of this Generator. These are types of potential hazards that may occur during this installation and operation:

! WARNING states a hazard may cause serious injury or death if precautions are not followed.

! CAUTION signals a situation where minor injury or product damage may occur if you do not follow instructions.

IMPORTANT NOTE: This highlights information that is especially relevant to a problem-free installation.

! WARNING BE CERTAIN ELECTRICITY IS SHUT OFF AT MAIN PANEL BEFORE ATTEMPTING TO WIRE OR SERVICE THE PC BOARD.

1. MS, MX, CT & SAH Generator PC Board Replacement only to be performed after consultation with a MrSteam Technical Service Representative.
2. REPAIR PROCEDURES MUST BE ACCOMPLISHED BY A QUALIFIED LICENSED ELECTRICIAN.
3. Use only MrSteam supplied replacement parts.
4. Follow all instructions in the Steam Generator Installation, Operation, and Maintenance Manual. This manual is provided with the generator and is also available online at: www.mrsteam.com/technical.

! CAUTION GENERATORS WITH EXPRESS STEAM AND MAX GENERATORS REQUIRE JUMPER ADJUSTMENT. FAILURE TO ADJUST JUMPERS MAY RESULT IN EQUIPMENT DAMAGE.

Default Jumper Location

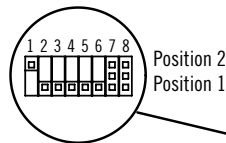

Express Steam Jumper Location

- Move Jumper 4 to Position 1

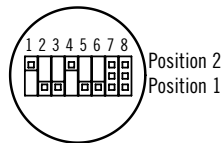

MX Generator Jumper Location

- Move Jumper 6 to Position 1

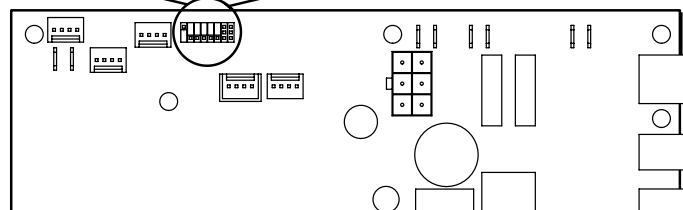
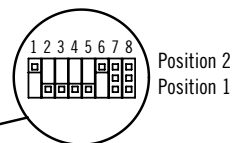

PC Board Replacement

1. Turn off breaker to the steam generator.
2. Unplug all connections to the right side of the generator, see figure 1.
3. Unscrew 2 screws on top cover and remove top cover to the generator, see figure 2.

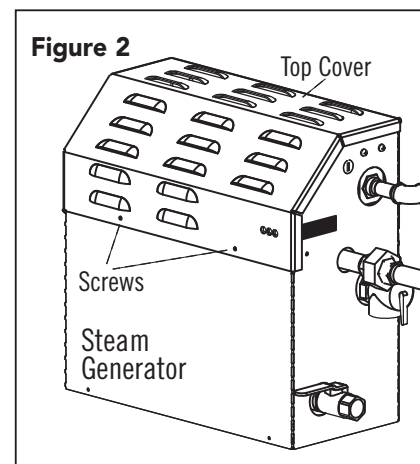
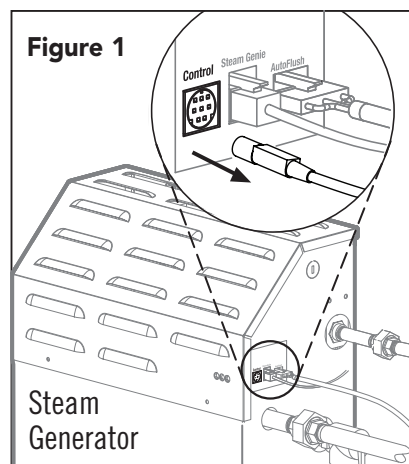
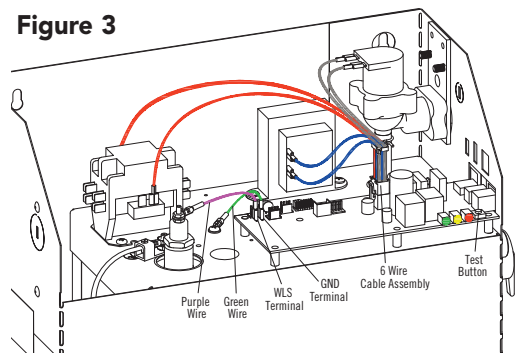
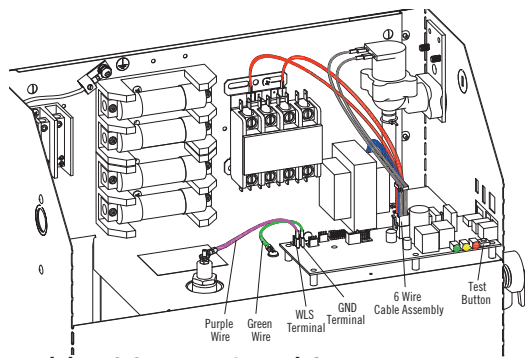

Figure 3



Models MS 90E-MS 400E (single phase wiring shown)



Models MS Super 1E-3E and CT6E-15E
(single phase wiring shown)

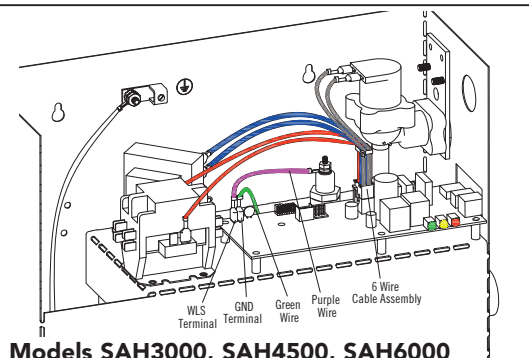

Models SAH3000, SAH4500, SAH6000

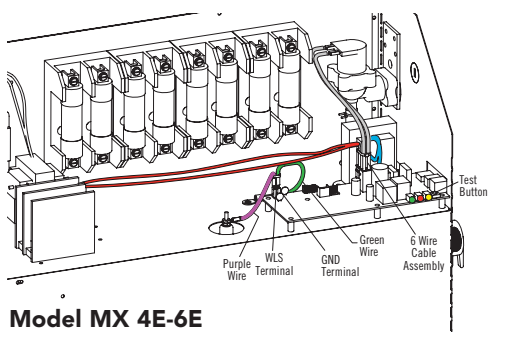

Model MX 4E-6E

4. Unplug 6 wire cable assembly from PC Board, see figure 3.
5. Unplug green and purple wire from PC Board, see figure 3.
6. Unplug all accessories connected to PC Board.
7. With a flat head screw driver, use its tip to push in triangular locking tab on white plastic standoff while pushing PC Board up with another hand, one standoff at a time, to remove PC Board, see figure 4.
8. Fasten new PC Board to 8 white plastic standoffs.
9. Plug green wire to GND terminal on PC Board, and plug in purple wire to WLS terminal on PC Board, see figure 3.
10. Plug in 6 wire cable assembly to PC Board, see figure 3.
11. Plug in control to the right side of generator, see figure 5.
12. Plug in all previously disconnected accessories.
13. Turn on breaker box.
14. Press Test Button on PC Board, see figure 3, it will let the generator run for 10 minutes
15. Press Test Button on PC Board again to turn off generator.
16. Place the generator's top cover back on and fasten 2 screws, see figure 2.

Figure 4

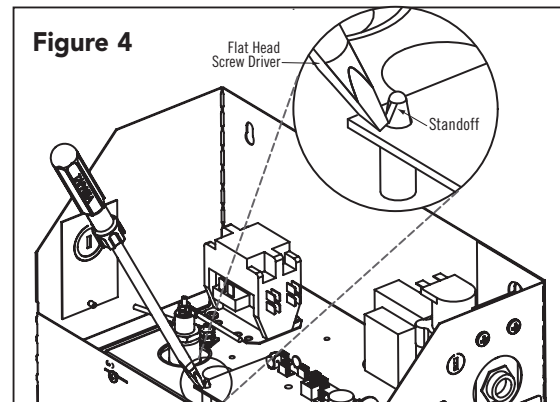

Figure 5

